

Installation & Handling Guidelines **SOLID TIMBER STRIP FLOORING**

Thank you for purchasing a Goodwood Tongue and Groove (T & G) Solid Timber Strip Floor. This product, with its natural beauty and durability, is produced from the same high grade timber that valuable furniture is manufactured from, adding warmth and value to homes, commercial and public buildings. The following guidelines have been written to assist in achieving the full potential of your timber floor by making you aware of installation and finishing requirements.

Product Specifications and Terminology

Solid Timber 19mm Strip Flooring is primarily designed as a structural product for installation over a seasoned bearer and joist subfloor. It can also be laid over existing sheet, old timber floors, or used in conjunction with battens. All these methods are subject to using the prescribed fixing method.

Flooring Sizes: The selection of board width (cover) is critical in determining the fixing process. Goodwood Flooring is produced in 65, 85, 108 and 133mm cover widths x 19mm in thickness (Fig 1).

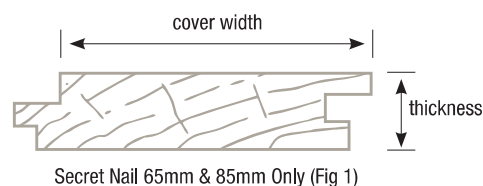

Profile: Whilst the profile for all sizes is identical, boards wider than 85mm cover are not suitable for “secret nailing” and must be “face/top nailed” (Fig 2).

Secret Nailing: Boards are fixed through the tongue to the joist (refer Fig 7) and are covered by the groove of the adjacent board.

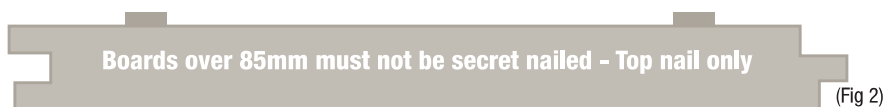

Top Nail: Boards over 85mm must be top/face nailed with two nails through the face surface to the joist (Fig 6).

End Matched: (E/M) Unless otherwise specified boards are supplied as an E/M product. This means boards will have a tongue on one end and a groove on the other which run adjacent to the T&G on the sides of the boards. End matched boards reduce the amount of cutting as they do not require docking and joining over joists as is required for plain end (P/E) boards (refer Fig 4).

Grades: Timber flooring is defined as either Select, Standard (medium feature) or High Feature grade.

These are determined by the amount of natural characteristics in the board.

**Profile & grade guidelines are as listed in Australian Standard AS2796.*

Moisture, Storage & Preparation

Moisture: Goodwood Flooring is produced to Australian Standard AS2796 which specifies a moisture content of 9% to 14%. Whilst this range is suitable for most ambient conditions throughout coastal Australia, it is a starting point only. Timber being a natural product will move in response to its environment. As the timber adjusts to its new location, its moisture content changes to equalise with the surrounding atmospheric conditions. Changes in temperature and humidity brought about by a range of artificial /natural factors (such as direct sunlight through large windows and heating or air-conditioning systems) are likely to have an impact on the physical dimensions of the boards. As timber absorbs moisture it expands and, as it loses moisture it shrinks, resulting in gaps between the boards. The floor will continue to move throughout its working life as it adjusts to these artificial and natural seasonal changes. To minimise this movement it is recommended that the timber be acclimatised where it is to be laid in its normal long-term working environment (heaters, air conditioning should be operational and direct sunlight through open curtains/blinds should be taken into consideration) for as long as possible before the floor is laid. (If in doubt seek advice from your specialist supplier).

The installer must determine the expected EMC range within the dwelling, then determine the moisture content of the delivered flooring with the use of a resistance moisture meter. Acclimatising at a humid or wet time of the year, where the EMC is high, can result in boards contracting during months of low humidity. When laying during these times, it is recommended to apply a coating that allows for movement.

Storage and Preparation: The timber floor must be protected from exposure to rain, dew, and direct sunlight at all stages of cartage, storage and construction. Flooring should be stored inside where it is to be laid, or in a similar environment. Do not store flooring on new or wet slabs. **Only install in a fully waterproof building.** Roof and other external cladding should be complete with windows and external doors installed and wet trades completed.

**Timber strip floors must not be built using the Platform floor method.
Goodwood Flooring that is exposed to extremes of weather before roofing will not be covered by warranty.**

Adequate **sub floor ventilation** and drainage is critical to avoid dampness. If moisture builds up under the subfloor from poor drainage and ventilation the floor boards will expand, resulting in cupping and lifting of the boards. Where ground conditions are damp and the potential for additional sub-soil drainage limited, the installation of a continuous impervious plastic membrane over the ground is recommended. If the underside of the floor is opened to elements it needs to be sealed and insulated.

**The Building Code of Australia outlines requirements for sub-floor ventilation and ground clearance.*

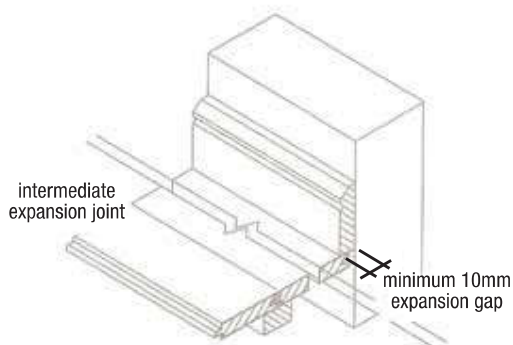

(Fig 3) Edge gap & intermediate expansion joint.

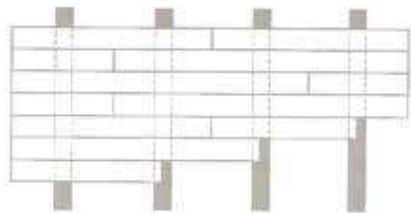

(Fig 4) End matched joints should be staggered and are not to occur in adjacent boards within the same span.

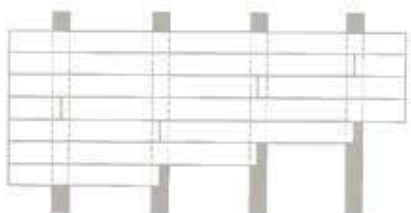

(Fig 5) Butt joints over joists should be staggered and are not to occur in adjacent boards on the same joist.

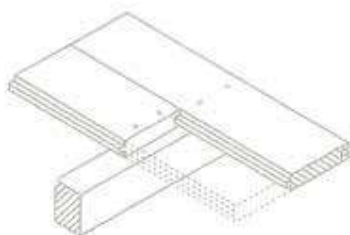

(Fig 6) Top Nail.

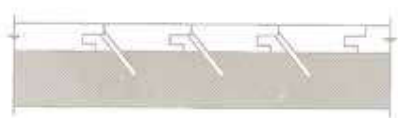

(Fig 7) Secret Nail.

Installation

Expansion Gap:

An expansion gap of 10 - 15mm must be left between the perimeter of the floor and walls (Fig 3). This can be covered by the skirting or flooring mould. Floors over 6.0M require intermediate expansion gaps. These can be located in door thresholds in line with elements such as stairs, or occur evenly throughout the floor in a series of smaller gaps.

Laying Boards & Joints:

Floor Boards should be laid in straight parallel lines. Boards should be firmly end butted together with **end matched** joints not occurring in adjacent boards within the same span between joists (Fig 4). **Plain end** boards should be joined over a joist with joints spaced a minimum of 450mm apart in adjacent rows and staggered throughout the floor (Fig 5).

Cramp Boards Tight:

Top/face nail boards should be cramped up in sections no greater than 900mm at a time. For **secret nailing**, cramp each board tight or use specialist nailing guns.

Fixing

Prior to fixing ensure cramped boards lay flat and have made full contact with the joists or sub-floor. Joists and bearers should be fully seasoned timber. Green timber will shrink and distort as it dries, leading to loosening of nails and an uneven floor surface.

Top/Face Nailing:

Boards over 85mm must be top nailed and fixed with two nails (Fig 6). Boards under 85mm in width only require one nail. Keeping the nail lines straight, fix at a minimum of 12mm from the edge of the board. Nails should be punched to a minimum of 3mm below the surface of the boards, ensuring boards are firmly seated onto the joists/substrate. To avoid splitting near end of boards or where joints are butted together it is recommended that nail holes be pre-drilled to 80% of the nail diameter.

Secret Nailing - not suitable for boards wider than 85mm:

When secret nailing, boards 85mm and under are fastened to the joist/substrate through the tongue of Goodwood Flooring profile at a 45 degree angle (Fig 7). Ensuring the boards are firmly seated, the groove side of the next board is inserted over the tongue of the nailed board covering the nail, hence secret nailed. Pneumatic secret nail guns are now commonly used which cramp the board and inserts a nail in a single motion.

Nail Fixing Requirements:

Minimum nail fixing requirements to Australian Standard 1684 for the hardwood and softwood joists are set out below (Table 1) (note: longer length nails required for softwood). Fixing for plywood (min 15mm) is also as defined.

Nail Sizes for 19mm T&G Flooring				
TABLE 1	Nailing	Softwood joists, Particle board	Hardwood & Cypress joists	Plywood substrate (15mm min thickness)
	Hand driven	65 ± 2.8mm bullet head	50 ± 2.8mm bullet head	a) 32x16 or 38x16 gauge chisel point staples b) 38x2.2mm nails at 300mm spacing c) 30x2.2mm nails at 200mm spacing
	Machine driven	65 ± 2.5mm	50 ± 2.5mm	

Glue used in addition to correct nailing:

Where vibration or dynamic loading is of concern, gluing flooring to joists may reduce later movement. Even if glued, the floor still needs to be fully nailed. Only use specialist elastomeric glues/adhesives such as Bostik Ultraset. **DO NOT USE HARD SETTING GLUES.**

Alternative Substrates:

Alternative timber substrates such as existing timber strip flooring, particle board and plywood, must be solid, securely fixed, level and dry (14% m.c and under). In a nailing and glue fixing combination, substrates should be skim sanded level to remove any imperfections (especially at joints or edges) and existing finishes. New boards laid over existing timber strip floors should be run at right angles. If nailing only application, nail to requirement of table 1. For particle board use nail sizes similar to softwood and ensure nails penetrate into joists.

Floor Finishes:

A range of floor coatings/finishes are available to suit your requirements. These include oils, water based polyurethanes, and 2 pack polyurethanes.

CAUTION: Whilst polyurethanes are hard wearing and produce a gloss finish, they also have a tendency to edge bond floor boards together and restrict free movement of individual boards. This can cause several boards to stick together and any shrinkage will result in these boards forming a panel and moving together. As a result, larger irregular gaps may appear across the floor between the panels. In extreme cases boards may split along their length.